

Ultrasonic Sonar Ranging IC - PW0268



SSOP20

Features:

- Operating Voltage: 6 – 10Vdc single source
- Operating Frequency: broadband output ranging up to 250KHz
- Variable R/C Oscillator: compensates for transducer resonate frequency drift due to temperature.
- High Gain Amplifier: varies with time over 32 steps
- Integrated Band Pass Filter: reduces external component count
- Bi-direction I/O Pin: simplifies the control function for transmitting a pulse and receiving an echo
- An adjustable System Clock: enables the control of, the number of pulses transmitted, the slope of the variable gain amplifier, and the pulse repetition rate.
- The PW0268 IC is suitable for use in car reversing aids, electronic tape measures and other sonar ranging applications.

Description:

The PW-0268 ultrasonic sonar ranging IC is ideally suited for echo ranging systems. This chip has many design features to enhance its performance and ease of use in this application.

The externally tunable RC Oscillator automatically tracks and compensates for the shift of the resonate frequency of the transducer due to temperature changes.

The Fix Gain Preamplifier can be tailored to compensate for varying transducer sensitivities. The 32-step Time Controlled Variable Gain Amplifier slope can be modified by adjusting the frequency of the system clock.

An onboard Comparator converts the analog signal of the returning echo to a TTL level digital signal for use with an external microprocessor.

The integrated Band Pass Filters can be adjusted for custom applications by changing a few external components. The frequency of the System Clock can be adjusted to control other operating parameters of the chip including the transmit pulse width and sample rate.

The I_O pin, (pin 1) is a bi-direction pin and is designed as an open collector connection with an internal pull high resistor. When the I_O pin is being pulled low by an external transistor, the RC oscillator generates a tone burst signal at DRIVER₀ (pin 11), the output driver stage for the transducer. After the transmit pulse, the I_O pin, (pin 1) will again go low if a valid echo signal is detected.

The reflected echo signal is presented to the first stage pre-amplifier through ECHO (pin 10). The gain of pre-amplifier can be adjusted to accommodate transducers with varying sensitivities by changing an external resistor between ECHO (pin 10) and GR_I (pin 9).

The 32 steps time controlled variable gain amplifier input TCG_I (pin7) and output TCG_O (pin 6) is synchronized to start incrementing at the end of control pulse signal I-O, (pin 1) and is reset at the beginning of the next control pulse.

Only a few passive components are needed for the active band pass filter. There are two stages, a low pass, LP_I (pin 5) and LP_O (pin 4) and upper band pass, HP_I (pin 3) to HP_O (pin 2). The center frequency and bandwidth of the filter are chosen based on the type of ultrasonic transducer being used and the specific application. The amplified echo signal after being filtered is routed to a comparator, which shapes and converts the analog echo signal into digital signal outputted at I_O (pin 1) for further μ P handling.

The unique temperature compensating Ultrasonic R/C Oscillator circuitry tracks the resonant frequency drift of the transducer that is caused by environment temperature changes. Simply adding dual diodes and one resistor between DRIVER_O (pin 11) and Ftrace (pin 12) is all that is needed to complete this function.

Block Diagram

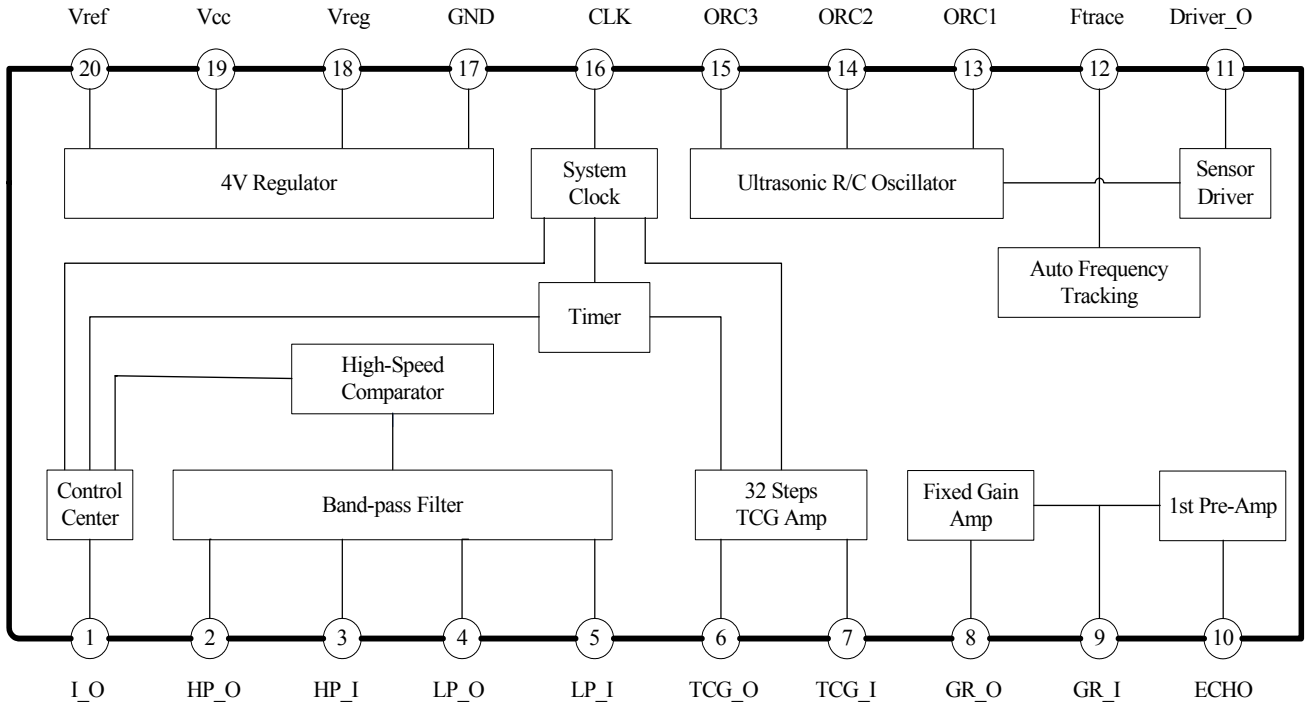

Pin Assignment

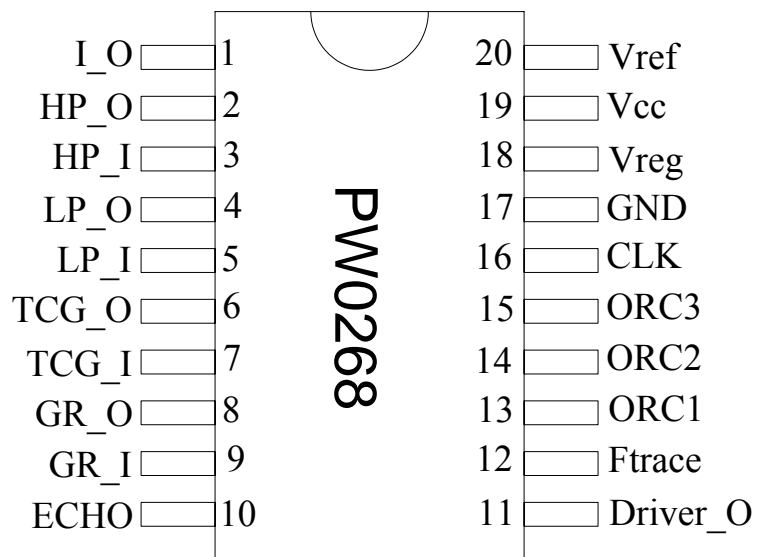

Specifications:

Unless otherwise specified, all data measured under $V_{cc} = 9V$, $F = 40KHz$

Parameter	Symbol	Condition	Min.	Typ.	Max.	Unit
Supply Voltage	Vcc	Vreg = 4V	5.5		11	V
Supply Current	Icc	$V_{cc} = 6 \sim 10V$	8	11	14	mA
Regulated Voltage	Vreg	$V_{cc} = 6 \sim 10V$	3.8	4	5	V
Stability of Vreg	Vlr	$V_{cc} = 6 \sim 10V, \pm 3\%$	-3.0	0	+3.0	%
Reference Voltage	Vref	$V_{cc} = 6 \sim 10V$, $R_L > 2K\Omega$	0.4	0.44	0.5	Vreg
Op-Amp Slew Rate	SR	$V_{in} = 3V_{pp}$	5	-	-	V/ μ S
Comparator Trigger Level	Tcomp	Over Vref	300	350	400	mV
System Clock Frequency	CLKf	$R=33K\Omega, C=22pF$	610	660	710	KHz
System Clock Frequency Range	CLKr		0.001	-	1500	KHz
Ultrasonic Oscillation Frequency	Fosc f	$R=5.6K, C=1000pF$	38	40	42	KHz
Ultrasonic Oscillation Frequency Range	Fosc r		0.001	-	500	KHz
2 nd Amp Gain	GR		29	30	31	dB
Time Controlled Gain Amplifier	TCGain	Min(1x, 0dB)	-1	0	+1	dB
		Max(58x, 35.2dB)	34	35	36	dB
Bandwidth of 2nd Amp	GRbw	Gain = 50dB	150	170	200	KHz
Driving Current	Idrv	Driver \bar{O}	-	20	40	mA
	Isink	Driver \bar{O}	-	-20	-80	
Input Voltage Level	I_OVIH		-	0.3	0.4	Vcc
	I_OVIL		0.15	0.2	-	
Output Voltage Level	I_OVOH		-	0.9	1	Vcc
	I_OVOL		0	0.05	-	
Input Low Level Current	I_OIOL		-	-10	-20	mA
I_O Internal Pull Up Resistance	Rup		3.5	5	6.5	K Ω

Absolute Maximum Ratings

Description	Symbol	Condition	Min.	Max.	Unit
Supply Voltage	Vcc		0	12	V
Operation Temperature	Topr		-40	+85	
Storage Temperature	Tstg		-65	+150	
Max. Pin Input Voltage	Vimax	I_O, Vcc	-0.3	Vcc+0.3	V
		Others	-0.3	Vreg+0.3	
Max. Input Current	Iimax	*	-10	+10	mA

*To prevent latch up, the instantaneous input current should be no large than 100mA for each pins.

Pins Description:

Pin	Name	Description	Pin	Name	Description
1	I O	Input/Output	11	Driver_O	Transducer driving output
2	HP_O	High pass filter output	12	Ftrace	Frequency tracing input
3	HP_I	High pass filter input	13	ORC1	RC oscillator: terminal 1
4	LP_O	Low pass filter output	14	ORC2	RC oscillator: terminal 2
5	LP_I	Low pass filter input	15	ORC3	RC oscillator: terminal 3
6	TCG_O	Time controlled gain output	16	CLK	System clock
7	TCG_I	Time controlled gain input	17	GND	Ground
8	GR_O	External adjustable gain output	18	Vreg	Regulated voltage for internal analogue devices
9	GR_I	External adjustable gain input	19	Vcc	Power supply
10	ECHO	Receiving echo input	20	Vref	Reference voltage output

Application Circuit: for car reversing aids (values should be changed for other applications)

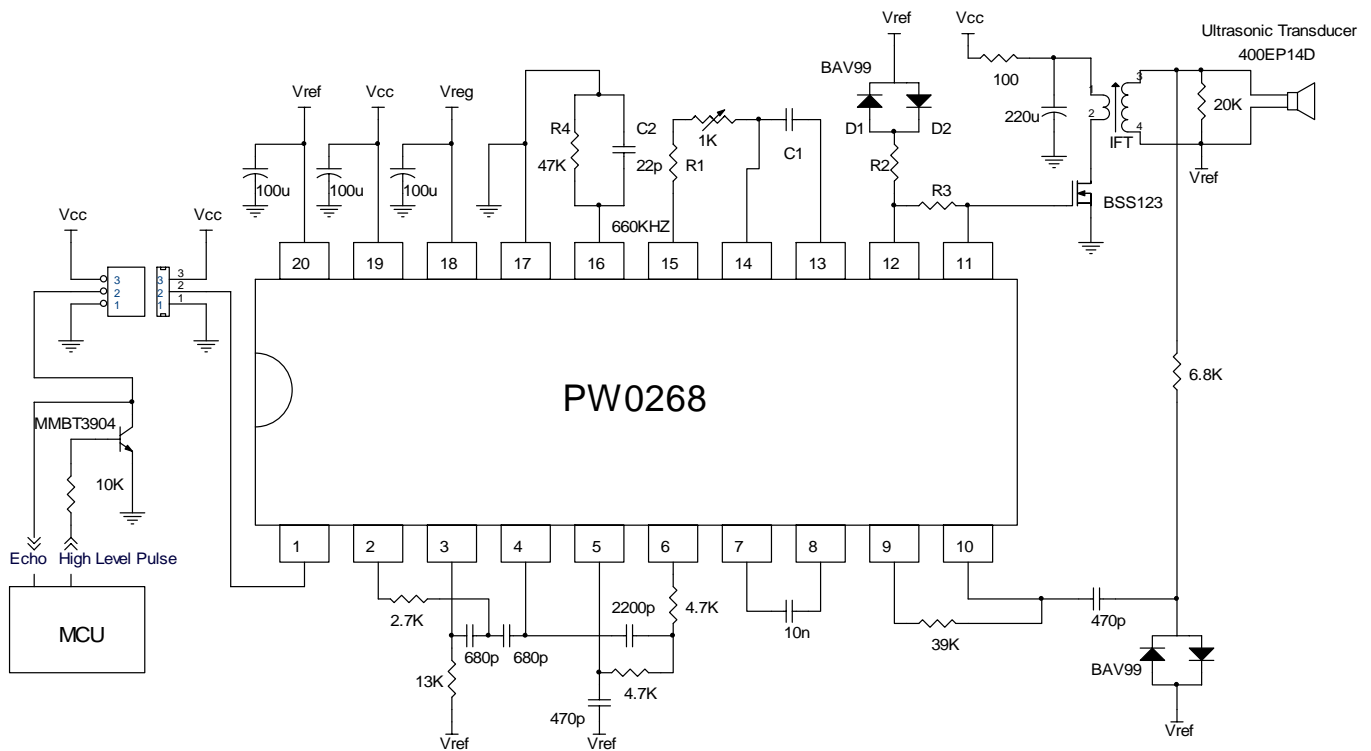

Application Note

The circuit shown on page 4 is a typical circuit for car reversing aids. The RC Oscillator generates a tone burst when a low level pulse is applied to the I_O pin, (pin 1).

To accommodate tolerance variations of transducers during manufacturing, a 1K-ohm variable resistor (R1) is provided to trim the output operating frequency. The range of adjustment is from 38.0 – 42.0 KHz. and allows for a better match of the drive signal to the resonate frequency of the transducer.

The active burst number (number of pulses transmitted) is controlled by the pulse width of the low level signal applied to the I_O pin, (pin 1).

The tone burst output, Driver_O (pin 11), drives the transducer through a MOSFET transistor and impedance matching transformer IFT. The inductance in the secondary winding of the transformer is designed to tune out the reactance of the parallel capacitance of the transducer.

The high output voltage of the tone burst is snubbed by two diodes and the returning echo signal is passed on to the first stage pre-amplifier. The signal is then passed on to the second stage fix gain amplifier and finally to the third stage 32-step time controlled variable gain amplifier. The gain of the pre-amplifier should be properly set to meet the sensitivity needs of the transducer and application requirements.

The center frequency of band-pass filter should be chosen to exactly match the frequency of the RC Oscillator and considerations for the width of pass-band filter should be made based on actual application requirements.

If the amplified echo signal from the output of the band pass filter exceeds $0.35V + V_{ref}$, the comparator will output a low pulse to the I_O pin, (pin 1). The width of the low level pulse is proportional to the echo signal strength.

The above description is summarized in the signal timing charts illustrated below.

MCU output: H: 1ms/Div., V: 2.0V/Div.

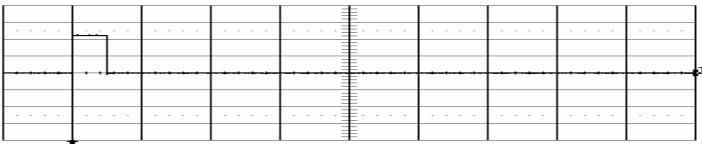

The RC oscillator will be enabled in the duration of input pulse. The maximum pulse width is $396/F$ and any time longer than this upper limit will be ignored.

Driver_O (Pin 11): H: 1ms/Div., V: 2.0V/Div.

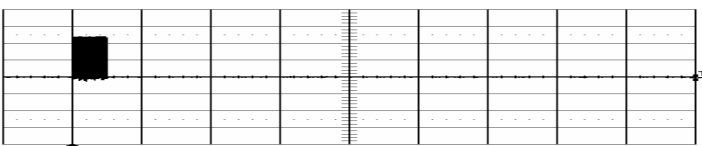

The next input pulse will be ignored if the pulse repetition rate is shorter than $9900/F + \text{pulse width}$.

F: Frequency of system clock

Transducer Oscillation: H: 1ms/Div., V: 50V/Div.

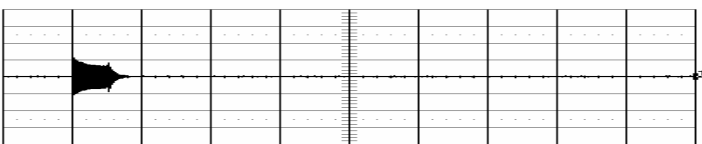

HP_O (Pin 2): H: 1ms/Div., V: 2.0V/Div.

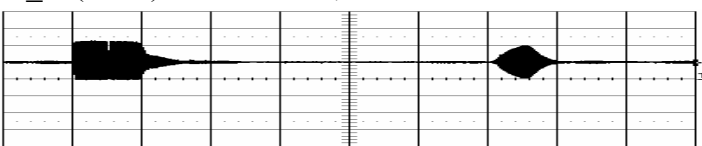

Output at Pin 1 I_O: H: 1ms/Div., V: 5.0V/Div.

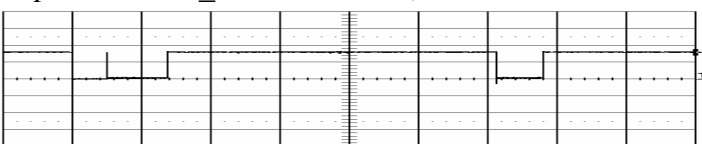

The resonate frequency of ultrasonic piezo transducers varies in an inversely proportional relationship to temperature. The lower the temperature, the higher the resonate frequency, the higher the temperature the lower the resonate frequency.

This property of piezo transducers may cause a mismatch between transducer and drive signal with changes in ambient temperature and reduces efficiency of the system when the frequency of the drive circuit remains constant and does not track the resonate frequency shift of the transducer.

Therefore it is desirable to have the output frequency of the drive source track the resonate frequency of the transducer with changes in ambient temperature. The Auto Frequency Tracking circuitry between Ftrace, (pin 12), and Drive_O, (pin 11) is used to accomplish this task.

The voltage change at Ftrace (pin 11) varies in proportion to the forward bias voltage change across diodes D1, D2. This change is caused by the negative temperature coefficient of the diodes and the ratio of the resistor circuit R2/R3.

A lower temperature increases the voltage drop across the diodes. This intern accelerates the charge rate of an internal integrator circuit controlling the R/C Oscillator, ORC3, (pin15). The net result is the adjustment to the R/C Oscillator increases the resonate frequency of the output, Drive_O, (pin11).

Conversely, a higher temperature decreases the voltage drop across the diodes. This slows the charge rate of the internal integrator circuit controlling the R/C Oscillator. The net result of this adjustment is to decrease the resonate frequency of the output Drive_O, (pin 11).

Choose values for the components R1, R2, R3 and C1 that will best track the characteristic resonate frequency shift curves due to temperature for a specific transducer.

Recommended values for the following transducers are listed below.

Used Transducer	R1(Ohm)	R2(Ohm)	R3(Ohm)	C1(pF)
400EP14D	3,300	1,500	511	2,200
400EP18A	3,300	1,500	604	2,200
235AC130	2,000	0	2,100	220

For a fixed output of 40KHz at Drive_O (pin 11) simply remove D1, D2 and R2 and set R1 = 4,500 Ohm, C1 = 2,200 pF, and R3 = 511 Ohm.

The system clock CLK (pin 16) controls the maximum input pulse width, the slope of time controlled gain amplifier and pulse repetition rate.

For example, as illustrated in the block diagram, if the system clock is set to 660KHz (C2: 22pF, R4: 47K Ohm), then:

- (1) The maximum input pulse width is $396/F = 396/660K = 0.6$ ms and any duration longer than 0.6ms will be ignored.
- (2) The step duration of the 32 step time controlled gain amplifier is equal to $220/F = 0.333$ ms, starting from the end of the pulse on the I_O pin, (pin 1).
- (3) The minimum pulse repetition rate is $9900/F + \text{pulse width} = 9900/F + 0.5$ ms (20 bursts of 40KHz) = $9900/660K + 0.5 = 15.5$ ms.

For long distance measurements of 18 meters (one way distance), the system clock should be set as follows:

Min. Pulse Repetition Rate = $9900/F + 0.75 = 166$ mS (30 bursts of 40KHz)

Frequency of System Clock F = 60 KHz

For additional information about an 18-meter tape measure circuit, please consult with the factory.

Time Controlled Gain Amplifier

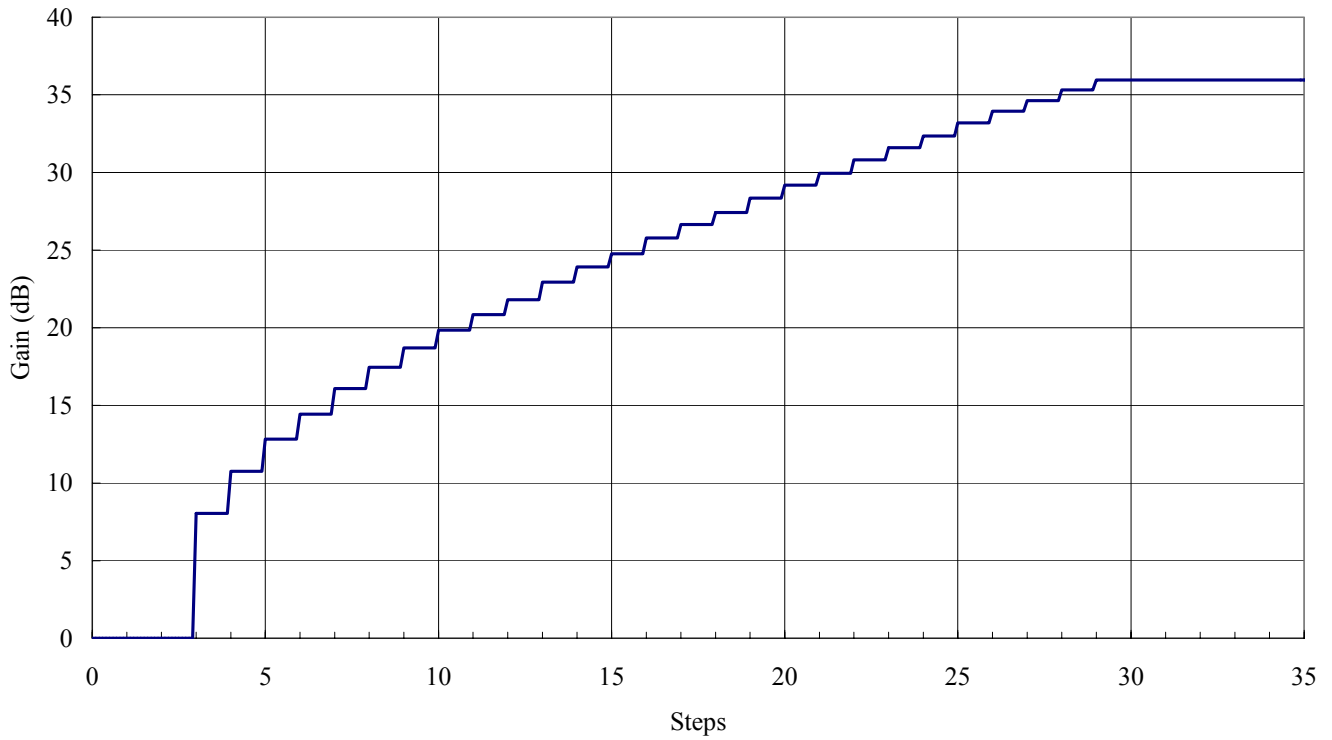

The time controlled gain amplifier is stepping up once the input pulse falling. The time duration can be calculated as:

$$T = 220/F$$

F: Frequency of System Clock

Package and Dimensions:

20 Pins, SSOP (150mil)

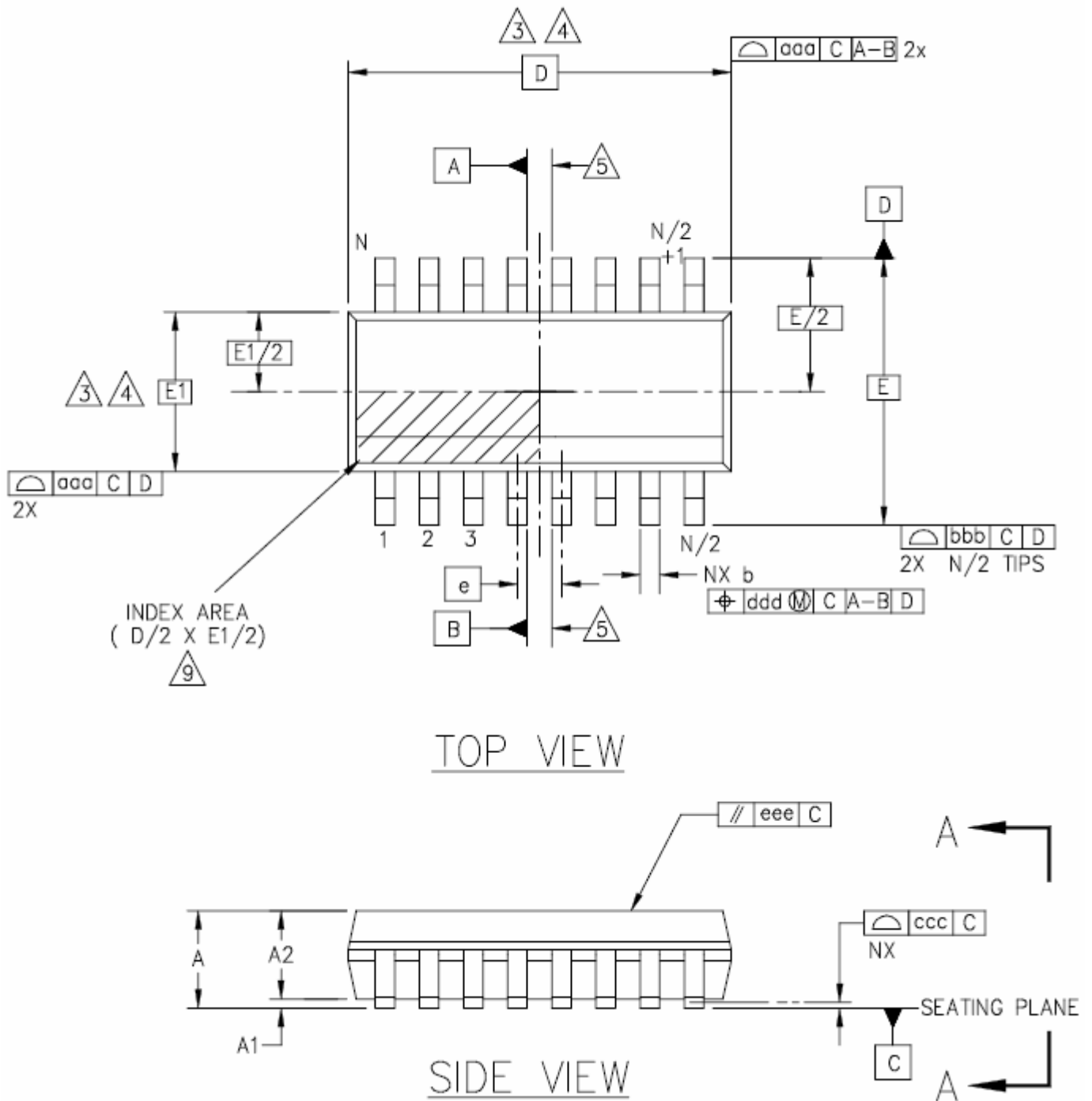

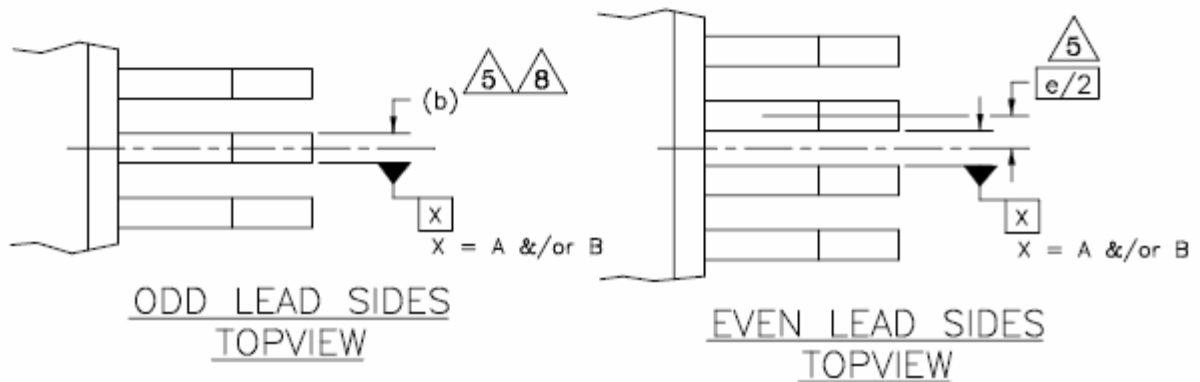
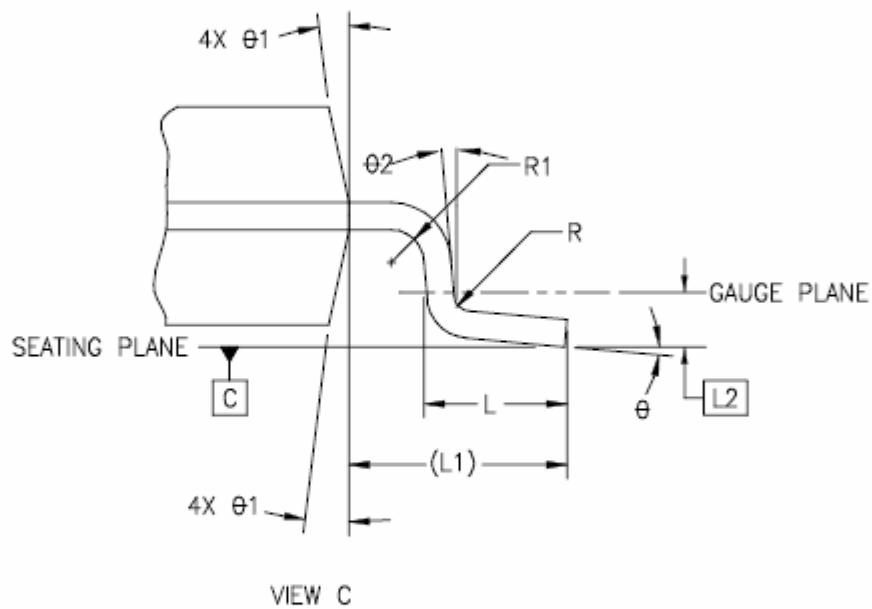
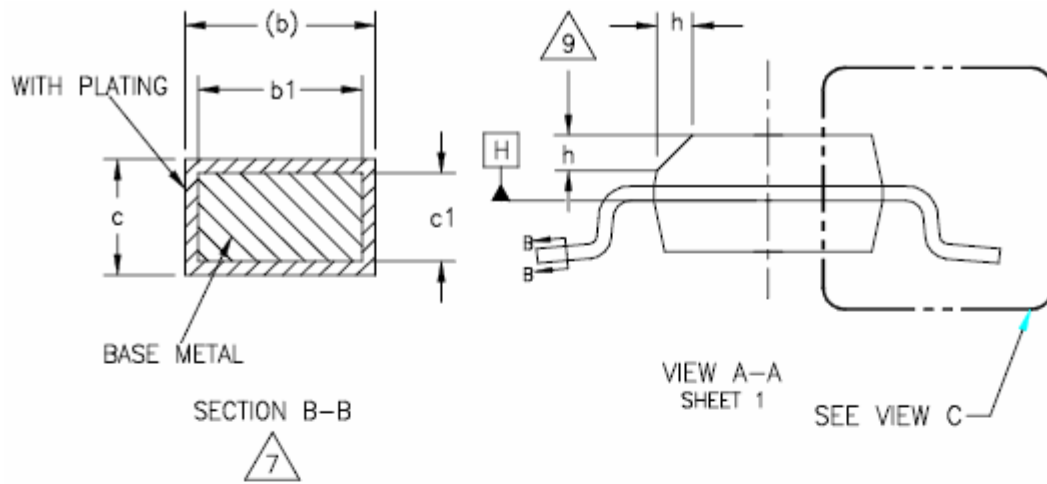

Symbol	Min.	Nom.	Max.
A	0.053	-	0.069
A1	0.004	-	0.010
A2	0.049	-	0.065
b	0.008	-	0.012
b1	0.008	0.010	0.011
c	0.006	-	0.010
c1	0.006	0.008	0.009
D	0.341 BSC		
E	0.236 BSC		
E1	0.154 BSC		
e	0.025 BAS		
L	0.016	-	0.050
L1	0.041 REF		
L2	0.010 BAS		
R	0.003	-	-
R1	0.003	-	-
θ	0°	-	8°
θ_1	5°	-	15°
θ_2	0°	-	-
aaa	0.004		
bbb	0.008		
ccc	0.004		
ddd	0.007		
eee	0.004		

Notes:

1. Dimensioning and tolerancing per ANSI Y14.5M-1982.
2. Dimensions in inches (angles in degrees)
3. Dimension D does not include mold flash, protrusions or gate burrs. Mold flash, protrusions or gate burrs shall not exceed 0.006” per end. Dimension E1 does not include interlead flash or protrusions. Interlead flash or protrusions shall not exceed “0.006” per side. D1 and E1 dimensions are determined at datum H.
4. The package top may be smaller than the package bottom. Dimensions D and E1 are determined at the outermost extremes of the plastic body exclusive of mold flash, tie bar burrs, gate burrs and interlead flash, but including any mismatch between the top and bottom of the plastic.
5. Datum A and B to be determined at datum H.
6. N is the maximum number of terminal position. (N=20)
7. The dimensions apply to the flat section of the lead between 0.004 to 0.010 inches from the lead tip.
8. Dimension b does not include dambar protrusion. Allowable dambar protrusion shall be 0.004” total in excess of b dimension at maximum material condition. The dambar can not be located on the lower radius of the foot.
9. Refer to JEDEC MO-137 variation AD.

JEDEC is the registered trademark of JEDEC SOLID STATE TECHNOLOGY ASSOCIATION